



MoistureShield

COMPOSITE DECKING

Installation & Maintenance Guide

MARCH 2021



[MOISTURESHIELD.COM](https://www.moistureshield.com)



Vision Cathedral Stone

The Next Level in Outdoor Living.

Create bold and inspired outdoor living spaces with MoistureShield® decking. Our diverse collection of products offer beautiful aesthetic options and innovative features to suit every deck design. At the foundation of every board is our proprietary Solid Core technology that fights damage from moisture, rot, insects and other harmful elements. Enjoy your outdoor space with minimal upkeep and lasting durability for years to come.

Table of Contents

- Planning 3
- Color & Texture 3
- Weathering 3
- Safety, Storage & Handling 4
- Design Inspiration. 5
- Preparation 6
- Fasteners 7
- Joist Layout 8
- Face Screw Installation 9 - 10
- Fascia Board Installation 11
- Batten/Sleeper Installation 12
- Stair Installation 13
- Hidden Fastener Installation 14 - 16
- General Cleaning & Maintenance 17 - 18
- Board Replacement Face Screws 19
- Board Replacement Hidden Fasteners 20 - 21
- Notes. 22 - 23

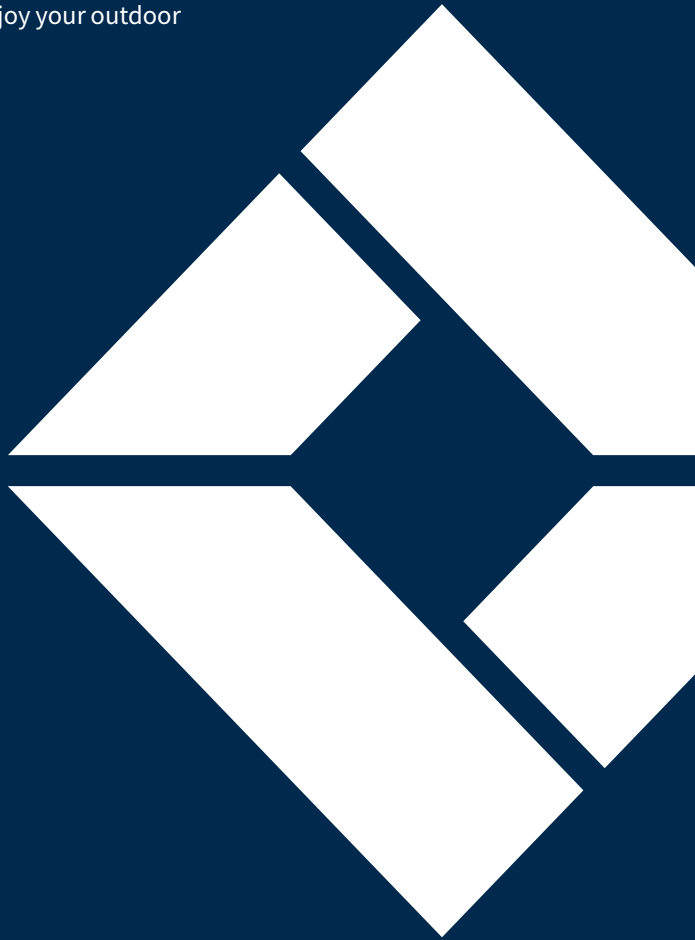

Planning

The purchaser or owner is solely responsible for determining the suitability of MoistureShield composite decking for its intended application, including whether the product conforms to applicable building codes or safety regulations in a particular area.

BUILDING CODES:

Check your local building code requirements in your area to ensure compliance. Be sure to obtain any required building permits and schedule applicable inspections.

WARRANTY:

Review the warranty information for your decking product before purchasing to ensure your application aligns with coverage guidelines. Fade and stain warranty varies by product line.

INSPECT YOUR MATERIAL:

Inspect your material prior to installation. In the unlikely event you receive defective materials, the product warranty does not cover labor. Once you alter a board (cut, rip, rout, screw, etc) it cannot be returned.

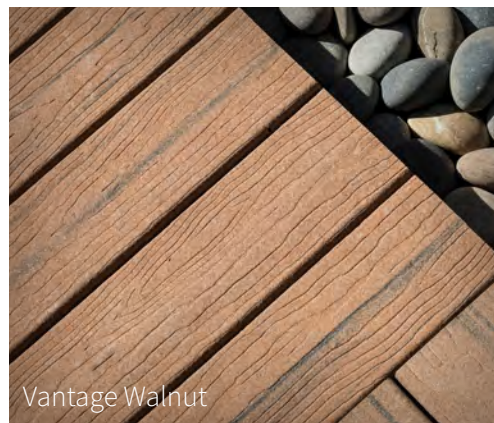

Vantage Walnut

Color & Texture

MoistureShield decking is manufactured to simulate the look and feel of natural wood. The variegation and slight texture difference on the surface of each board is deliberate and does not affect the Solid Core® durability.

LAYOUT YOUR MATERIAL PRIOR TO INSTALLATION. During the planning phase, arrange the deck boards before installation to achieve the desired pattern and color effect. This is especially important if using different board lengths or material from multiple units. Mix boards as needed to achieve your desired look in terms of continuity of color and surface texture.



Elevate Alpine Gray

Weathering (Vantage only)

The Vantage line is engineered to naturally weather and lighten to its forever color within the first 3 to 6 months after installation. If you move furniture, you may notice the newly uncovered area is darker. Please note this is normal; the area will lighten to match the rest of the deck within 3 to 6 months if left uncovered. Vantage does not have a fade warranty. Visit MoistureShield.com to see examples of weathered Vantage boards.



Safety, Storage & Handling

Below are jobsite storage and handling recommendations to ensure your MoistureShield decking products look their best for installation. Our Yard Storage & Handling Guidelines available at moistureshield.com provides additional information for commercial settings.

Safety

As when working on any construction site, be sure to follow good safety practices. Wear appropriate protective equipment and clothing, such as eye protection and safety gloves. When using power tools, follow the manufacturer's instructions for proper use and safety guidelines; use any protective guards included with the tool. Safety Data Sheets (SDS) are available at moistureshield.com.



Storage

KEEP IT WRAPPED: Leave the original unit bands, pallet boards, and outer wrap in place to ensure the decking boards remain clean and protected from exposure to the elements. Cover boards on the jobsite to avoid premature fading, weathering, or staining.

KEEP IT FLAT: Always store MoistureShield decking products on a flat surface to prevent bowing over extended periods of time. Stack units no more than 10 high of the same board length per stack.

KEEP IT SAFE: Do not store near strong oxidizing agents, combustible material, or sources of heat. Never burn MoistureShield decking in a fireplace or use as firewood.



Stable Stack of Decking Units

Handling

PRACTICE GOOD FORKLIFT TECHNIQUES: Follow all standard safety procedures and verify the load is within your forklift's weight capacity to ensure safe travel. Spread the forks as wide as possible with the load centered across the forks to minimize sagging. Lift the load high enough to allow 2" clearance from each end of the unit and the ground.

HANDLE WITH HELP: Loose boards are heavy and may flex more in warmer temperatures, so carrying planks should be a two-person job.

HANDLE WITH CARE: Use caution when maneuvering material to avoid striking and damaging the planks.

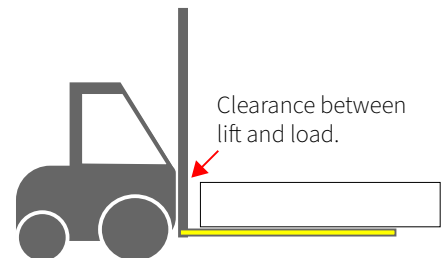
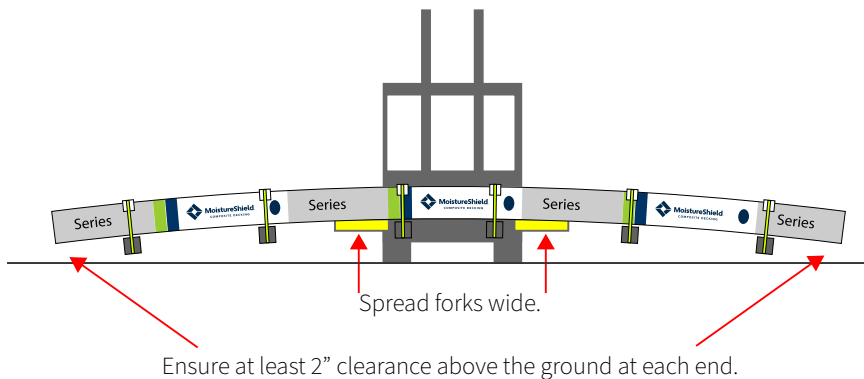

Endless Design Options!



Elevate Lake Fog



Vision Spanish Leather & Mochaccino



Vantage Cape Cod Gray

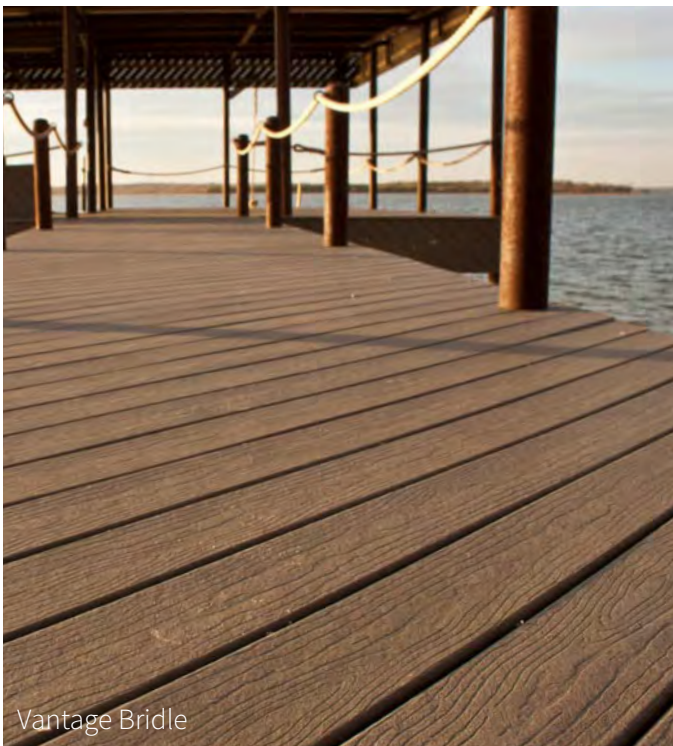

Vantage Bridle



Meridian Citadel



Preparation

Consult your local building code authority for substructure and installation requirements for all decking applications, including roof and multi-level installations, to ensure compliance.

Tools:

- Circular saw with carbide-tipped blade (max 20 teeth), 10" or 12" miter saw with carbide-tipped blade (40 teeth)

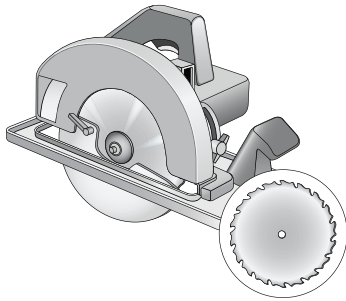

- **Blue chalk line***
**To avoid staining the deck boards, only use blue carpenter's chalk.*



- Tape measure

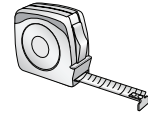

- Eye protection



- Ear protection



- Screw gun

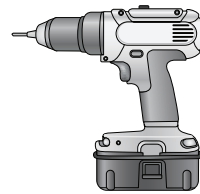

- Hammer

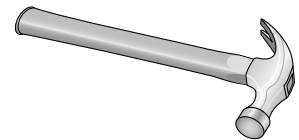

- Level

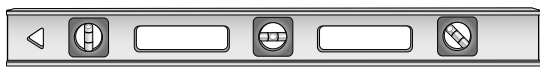

- Rasp 1/4" (6mm) Round (**Vantage only**)



**Router or rasp the cut ends of Vantage deck boards for a smooth finish. Do not rasp Vision, Meridian, and Elevate boards.*

DO NOT USE YOUR DECK AS A WORK BENCH.

It's important to keep your deck free of excess dirt, dust, debris, pavers, and other building materials during construction. Using your deck as a storage place for building materials risks permanent damage from sharp objects or accidental strikes.

Each board is slightly longer than the advertised length, allowing the installer to square off the board prior to installation.

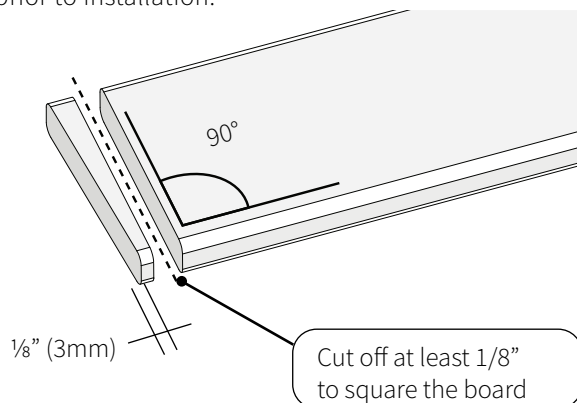

When installing any fasteners, affix the screws centered on the joint to ensure optimal bite.

FOR ELEVATE: pre-drill the board with a 5/32" drill bit to ensure the screw does not shift during installation through the bottom scallop. Take care not to pre-drill into the joist to ensure proper bite. Do not countersink face screws; they should remain flush with the board surface.

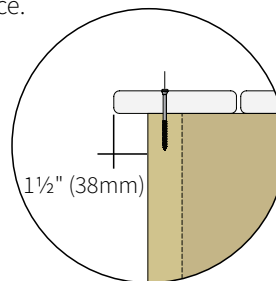

Vision, Meridian, & Vantage

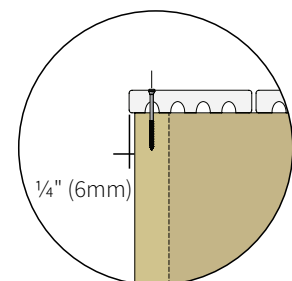

Elevate

Any deviation from the directions given in this guide may result in voiding of the MoistureShield warranty.



Fasteners

Select a type of fasteners that works best for your installation method and desired look.

Face Screw:

#7 stainless steel trimhead screws or color match composite decking screws.

NOTE: if installing Elevate boards, do not countersink face screws; they should remain flush with the board surface.

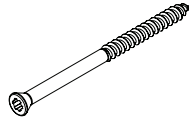

Face Screw with Plug:

Fasteners with color match plugs to conceal countersunk face screws; requires custom bits.

NOTE: plug systems are not compatible with Elevate.



MoistureShield Hidden Fasteners:

Compatible with grooved profile boards to create an unblemished deck surface.

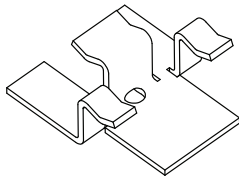

Standard Clip

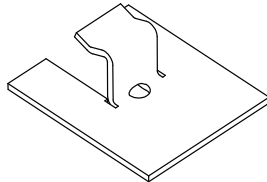

Transitional Clip

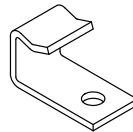

Starter Clip

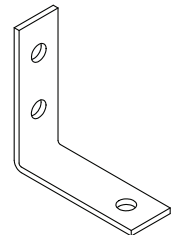

Finishing Clip
Not compatible with Elevate

MoistureShield® Deck Clips provide superior holding power with a custom design that fits securely into the grooved profile of a MoistureShield deck board. Like our composite decking, our clips are both beautiful and durable, extending the life of your deck by elevating the boards off the joists to reduce structural rot and mold.

Fastener Systems:

Pro Plug® Composite Tool

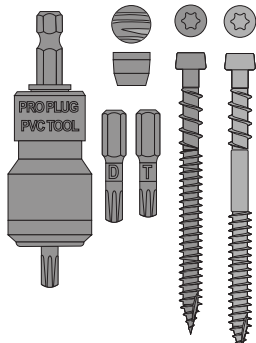

- Plugs made from MoistureShield board material
 - Auto stop mechanism with free spinning stop collar
 - Special bits for deck and trim applications
 - Grade 305/marine grade 316 Stainless and epoxy coated star drive fasteners
- (Not approved for use on Elevate)*

Deckfast® Fascia System

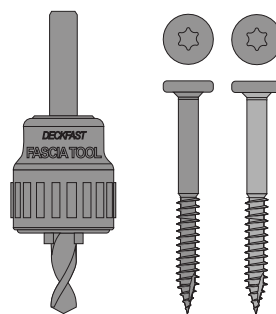

- Fascial tool with pre-set countersink and shaft length
- Fascia screws color matched stainless steel and epoxy coated steel

Cap-Tor® xd

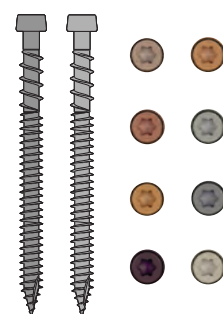

- Cap-Tor xd epoxy coated carbon steel
- Cap-Tor xd Headcote stainless (grade 305 and Marine grade 316)

Contact your local Starborn representative for additional information



Joist Layout



PRO TIP: It is important to check the joists, whether new or pre-existing, are level. Composite deck boards will follow any contour left by an unlevel substructure.

Layout and install joists. Joist spacing can vary depending on exact material profiles being used. This joist layout illustrated below is based on the most common 1" thick plank size.

Span Chart					
Nominal Board Size:	1x5.4	2x4	2x6	2x8	Fascia
Perpendicular Span Rating	16 in OC (40cm)	16 in OC (50cm)	24 in OC (60cm)	24 in OC (60cm)	N/A
Angle Span Rating	12 in OC (30cm)	12 in OC (30cm)	16 in OC (40cm)	16 in OC (40cm)	N/A

Layout and install joists at 16" (40mm) on-center (OC) when decking will be installed perpendicular to the joists for 1x5.4 boards.

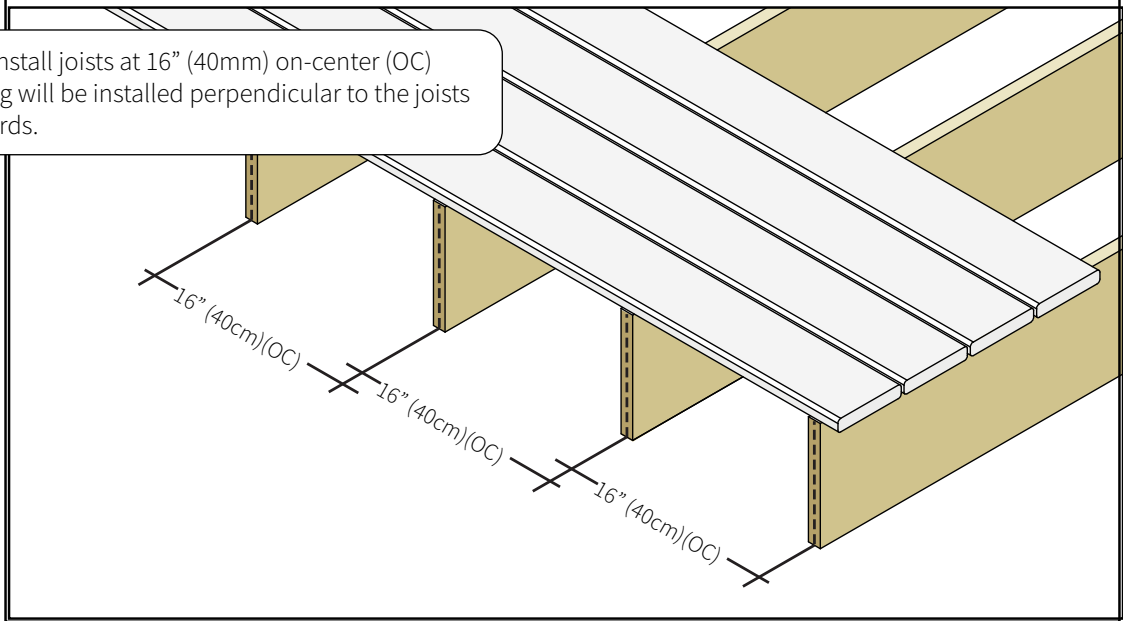

Layout and install joists at 12" (30mm) on-center (OC) when decking will be installed at an angle to the joists for 1x5.4 boards.

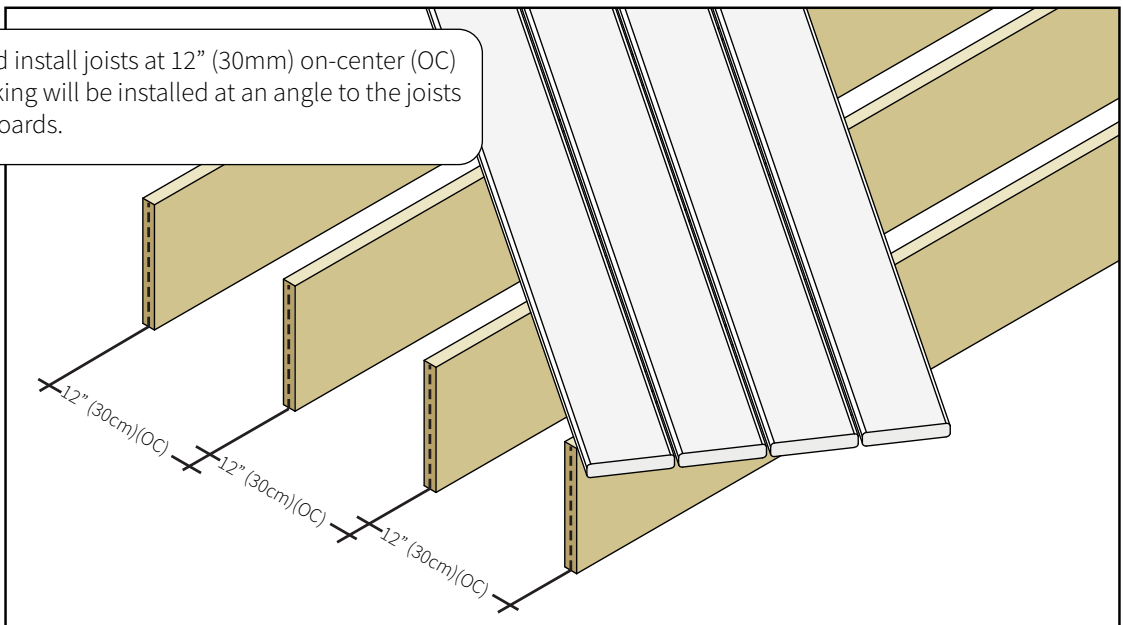

PRO TIP: Never install fascia boards as a walking surface. They are not designed to carry the required load of a decking surface.



Face Screw Installation

Allow $\frac{3}{16}$ " (5mm) to $\frac{1}{4}$ " (6mm) edge-to-edge spacing between deck boards.

Screws should be a minimum of $\frac{3}{4}$ " (19mm) from the board ends and edges.

Allow $\frac{1}{8}$ " (3 mm) or greater end-to-end spacing between boards (butt joints). Additional details on page 8.

Install the first board with an appropriate gap abutting the house to allow for drainage based on your local building codes. Be sure the first board is straight and properly secured to prevent shifting of subsequent boards.

Use a spacer to maintain consistent edge-to-edge gaps when installing each board.

For the optimal finished look, plan your deck to allow boards of full width across the entire surface.

Install deck boards with two fasteners per board per joist. Be sure to center the screws to the joist.

Nominal Board Thickness	Screw Length
1" thick	2- $\frac{1}{4}$ " or 2- $\frac{3}{4}$ "
2" thick	2- $\frac{3}{4}$ " or 3"

Pro Tip:
Using a 2" (50.8 mm) driver bit allows you to better gauge screw depth.

Once all boards are in place, snap a blue chalk line across the ends of the boards to the desired overhang. Leave at least $\frac{3}{16}$ " (5mm) overhang to conceal rim joist imperfections.

Adjust the blade depth of your saw to match the thickness of your deck boards. Carefully cut along the chalk line.

TIP: Only mark the boards with the blue chalk line or pencil where you intend to cut out.

Cut along the blue chalk line

Vision, Meridian, & Vantage **Elevate**

Board Profile	Maximum Overhang
Solid Bottom	1- $\frac{1}{2}$ " (38mm) from edge of rim joist
Scalloped Bottom	$\frac{1}{4}$ " (6mm) from edge of rim joist or edge of properly secured fascia board



Butt Joints

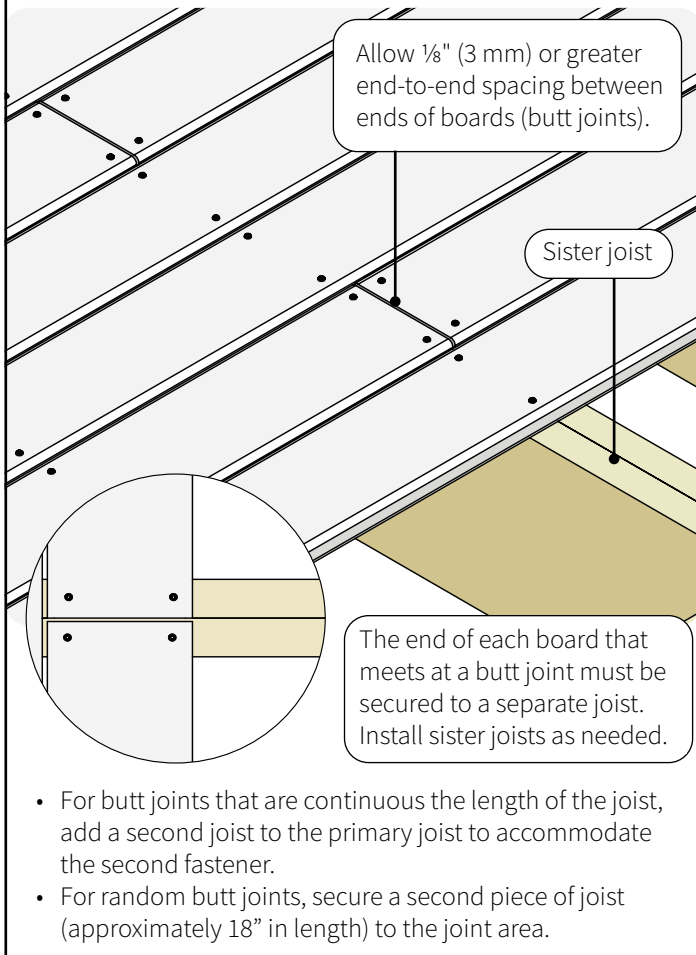

- For butt joints that are continuous the length of the joist, add a second joist to the primary joist to accommodate the second fastener.
- For random butt joints, secure a second piece of joist (approximately 18" in length) to the joint area.

Pro Tip: Staggering the butt joint improves the overall appearance of the finish deck.

Feature Boards

For an interesting design, install a feature board to define spaces within the decking surface or eliminate staggered butt joints.

Install joists to accommodate fasteners at the ends of the boards abutting the feature board.

Use spacers to ensure a consistent gap between the edges of the feature board and the abutting board ends to allow for proper expansion and contraction.

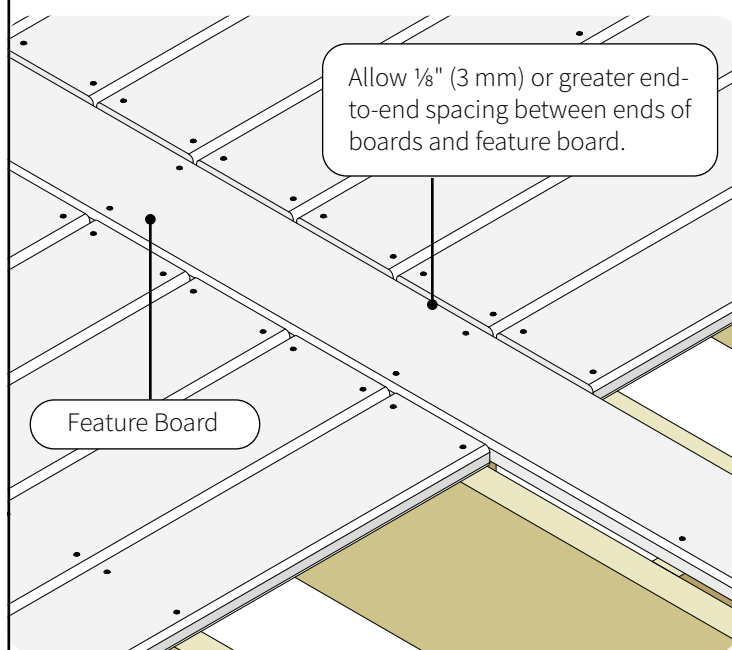

Pro Tip: Use a complimentary color for the feature board and picture frame to create visual contrast and enhance the deck.

VANTAGE ONLY - Conceal Screw Heads

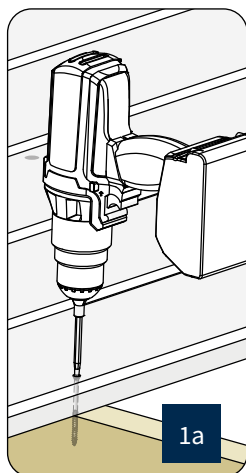

Step 1: Countersink screw into the decking surface. DO NOT wipe away the displaced material.

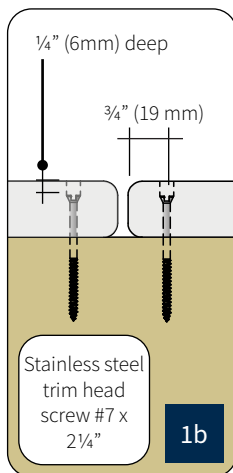

Stainless steel trim head screw #7 x 2 1/4"



Step 2: Using your thumb, gently push the displaced decking material into the hole left by the screw.

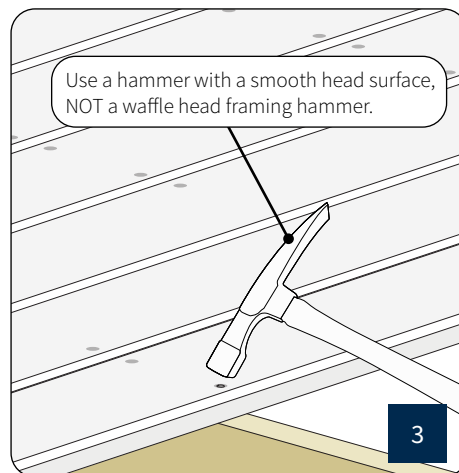

Use a hammer with a smooth head surface, NOT a waffle head framing hammer.

Step 3: Tap the material with a flat hammer to compress it into the hole. Vantage will self-heal with sun exposure.



Fascia Board Installation

Install fascia boards under the decking surface overhang. Do not install fascia boards flush to the decking surface.

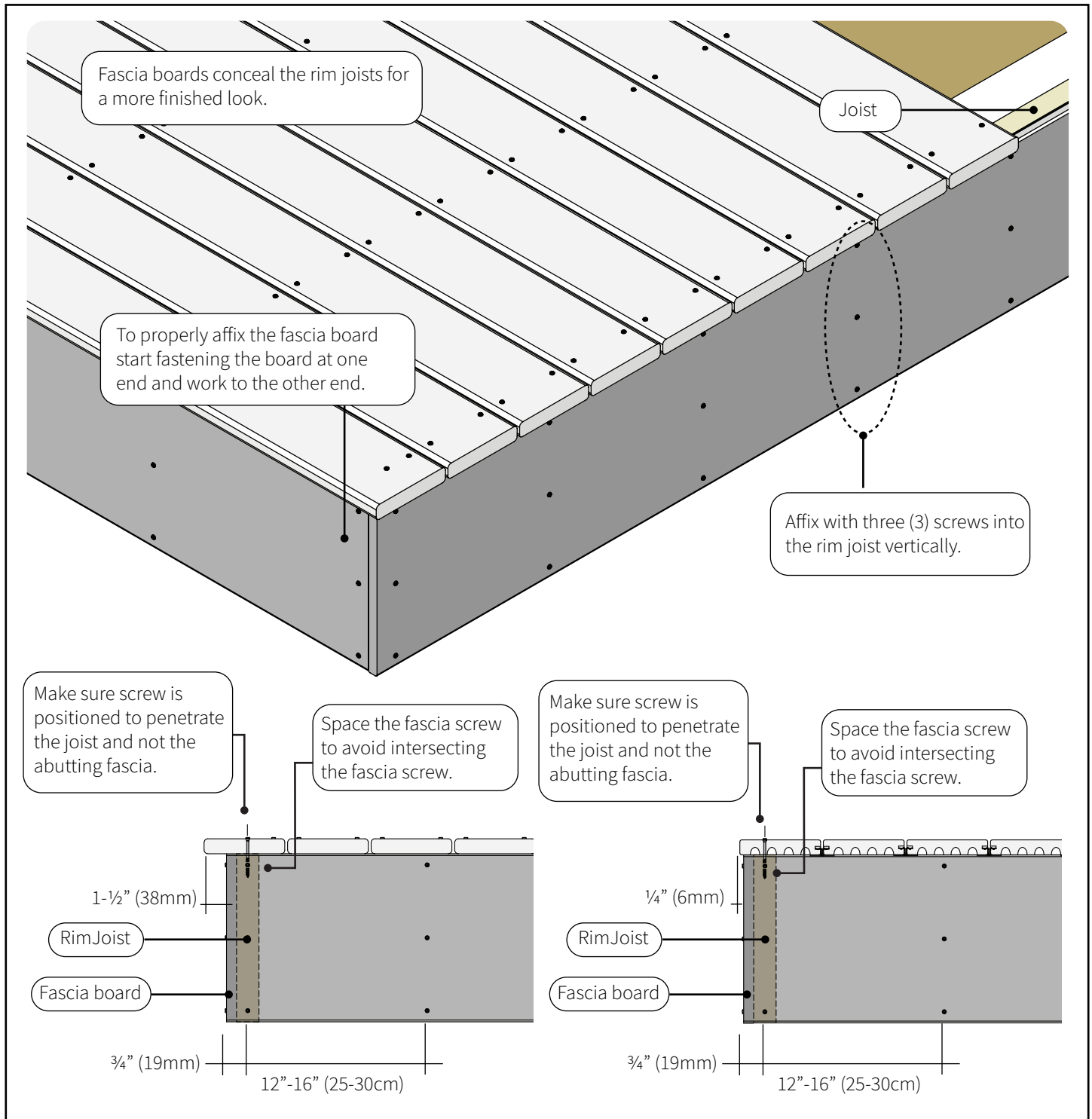

Pro Tip: Decide if you will install fascia while planning your deck design. The thickness of the fascia board will impact the overhang (see reference chart to the right).

Board Profile	Maximum Overhang
Solid Bottom	1-½" (38mm) from edge of rim joist
Scallop Bottom	¼" (6mm) from edge of rim joist or edge of properly secured fascia board



Batten/Sleeper Installation

A batten/sleeper system is a substructure supporting the MoistureShield decking surface above a solid foundation surface. Drainage, access, and airflow are essential for the longevity of the installation. Water must be able to freely flow between the boards and away from the deck substructure. For repairs and removal of debris, joist access may be necessary. In ground-level installations, use face screws instead of clips to secure the decking. NOTE: It is important that the sleeper joists are made of a high-quality product (such as our Vantage product) that is rated for ground contact to ensure warranty coverage.

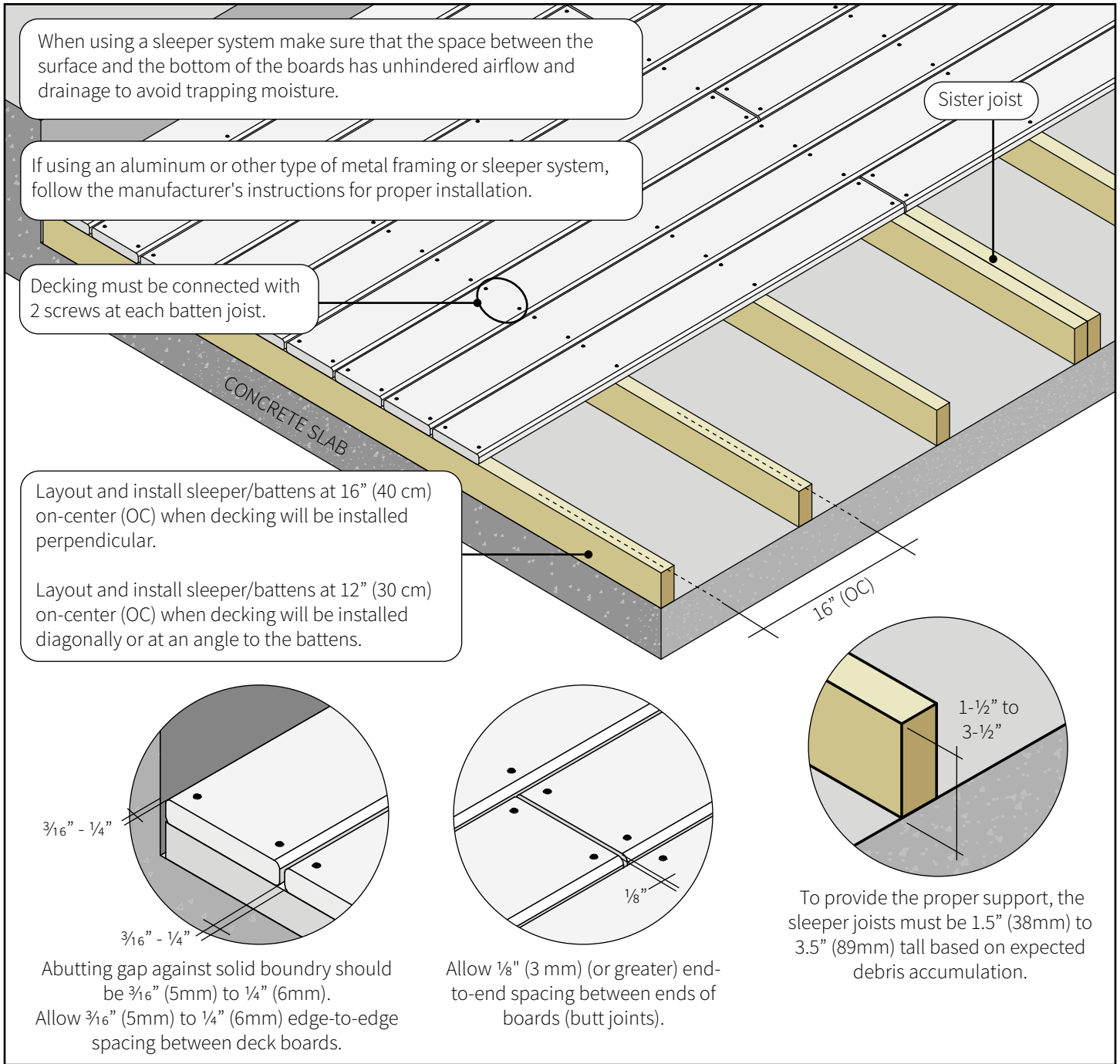

Be sure to check local building codes for any decking installation, including batten/sleeper installations and rooftop decking applications, to ensure compliance.



Stair Installation

Prior to construction, check with your local regulatory agency for special code requirements in your area. Never use fascia as a walking surface; fascia is not designed to support the required loads for a deck surface.

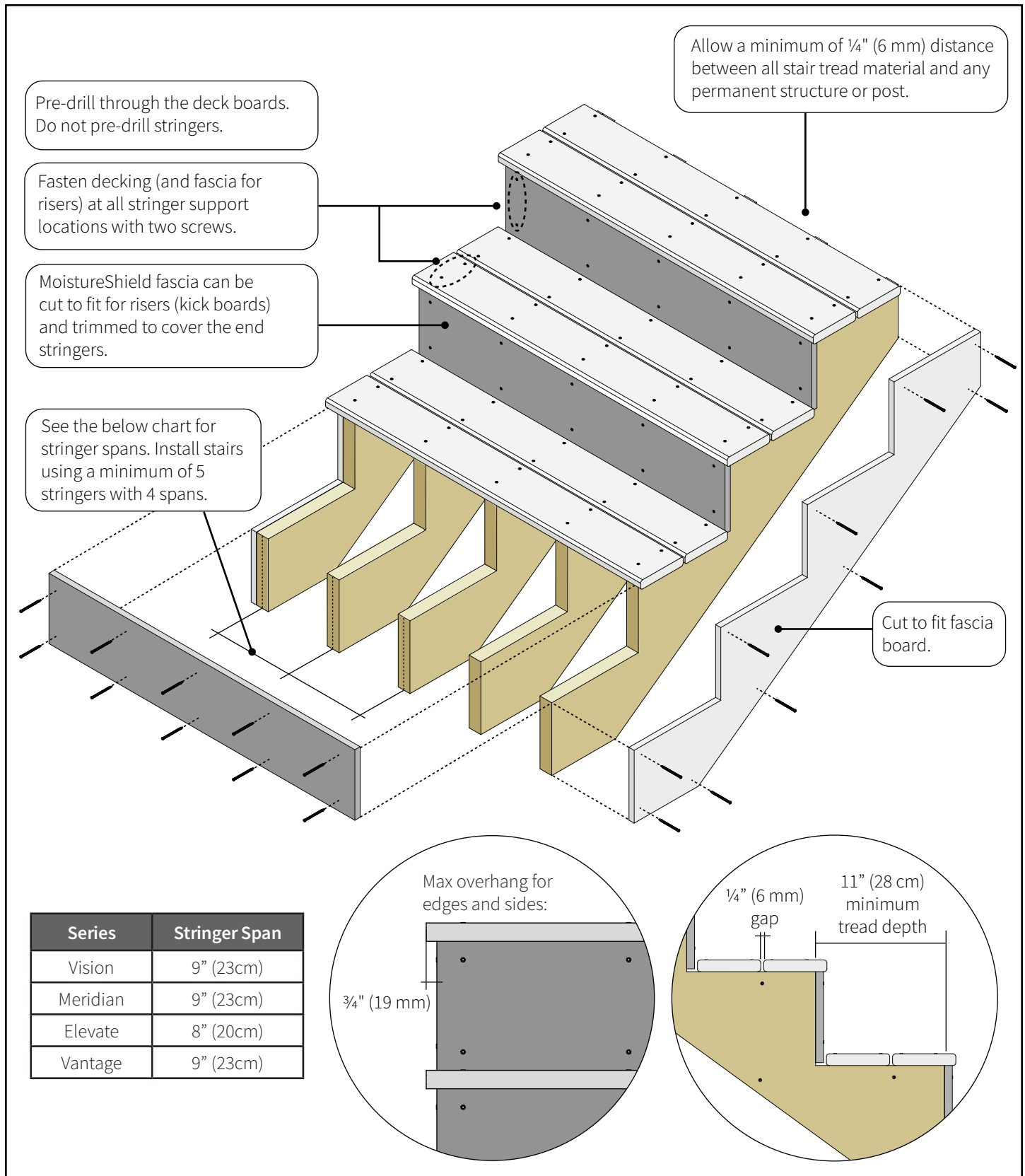

Hidden Fastener Installation



- Complete system**
Covers 50 square feet of decking
- 90 clips
 - 100 screws or 100 pneumatic fasteners
 - 5 starter clips
 - 5 finish clips



- Deck/Contractor pack**
Covers 250 square feet of decking
- 450 clips
 - 500 screws (Deck Pack) or 500 pneumatic fasteners (Contractor Pack)
- *Starter and finish clips sold separately*

All clips available in carbon steel or stainless steel.

Benefits

- Concealed deck clips allow for an unblemished deck surface
- Base of clip elevates the board off the joists, reducing rot, mold, ice shear and lateral load stress
- Evenly spaces the deck boards $\frac{3}{16}$ " for a uniform appearance
- Available in carbon steel or 304 grade stainless steel with a patented coating process to resist corrosion
- Approved for ACQ and all other pressure-treated joists.

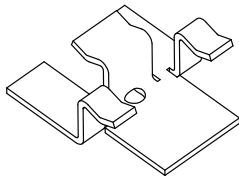
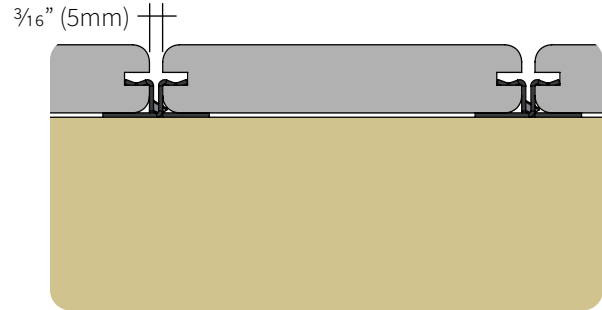

Standard Clip

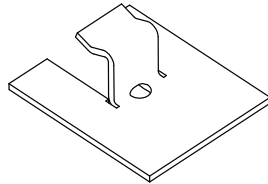

Transitional Clip

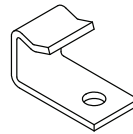

Starter Clip

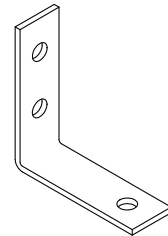

Finishing Clip
Not compatible with Elevate

Starter Clip

Line up the back (vertical leg) of the Starter Clip in position for the first deck board. Fasten this clip to the joist with the fasteners supplied. Slide deck board groove into Starter Clip tab.

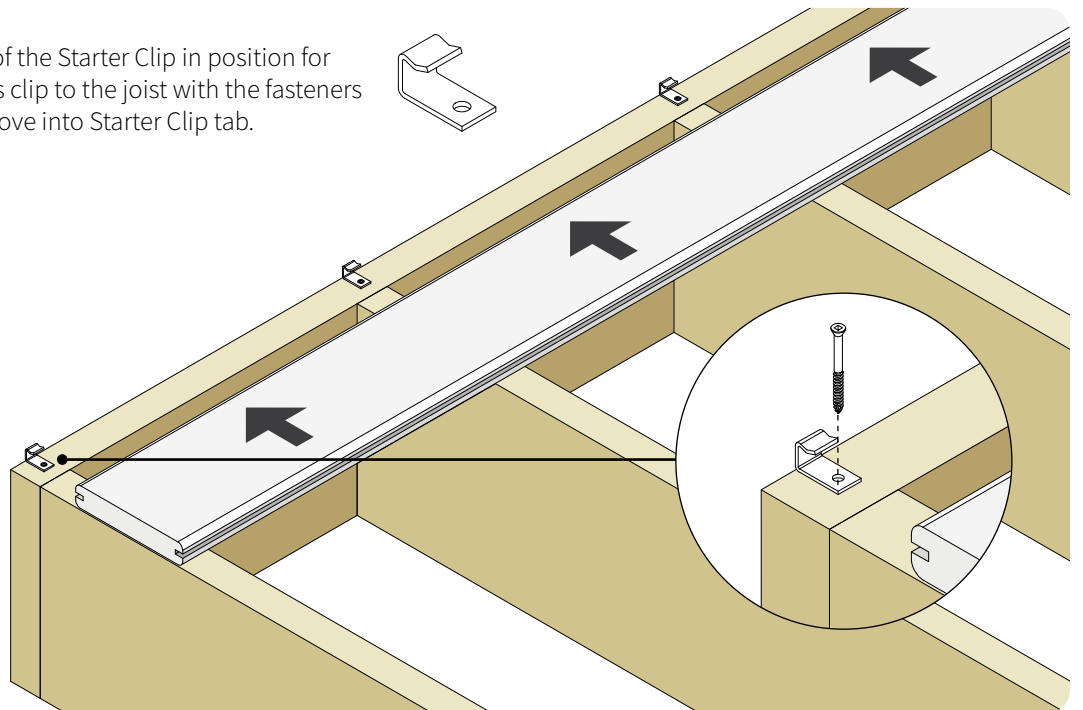
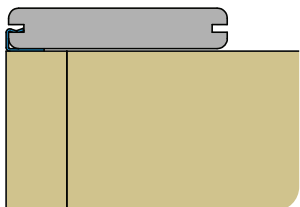
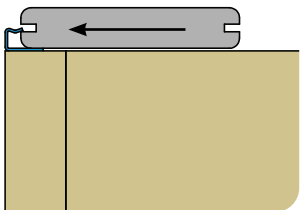

MoistureShield Clip

If using traditional screws: place the MoistureShield Clip into the deck board groove and fasten to the joist using the screws supplied. Repeat step until the last deck board is slid into the clip.

If using pneumatic fasteners: place the MoistureShield Clip into the deck board groove and fasten to the joist with pneumatic fasteners supplied. Repeat step.

Lift the back edge of the board slightly to help engage the leading edge with the clip.

Firmly slide boards into place with caution. Too much force may collapse the clip arms and cause uneven spacing.

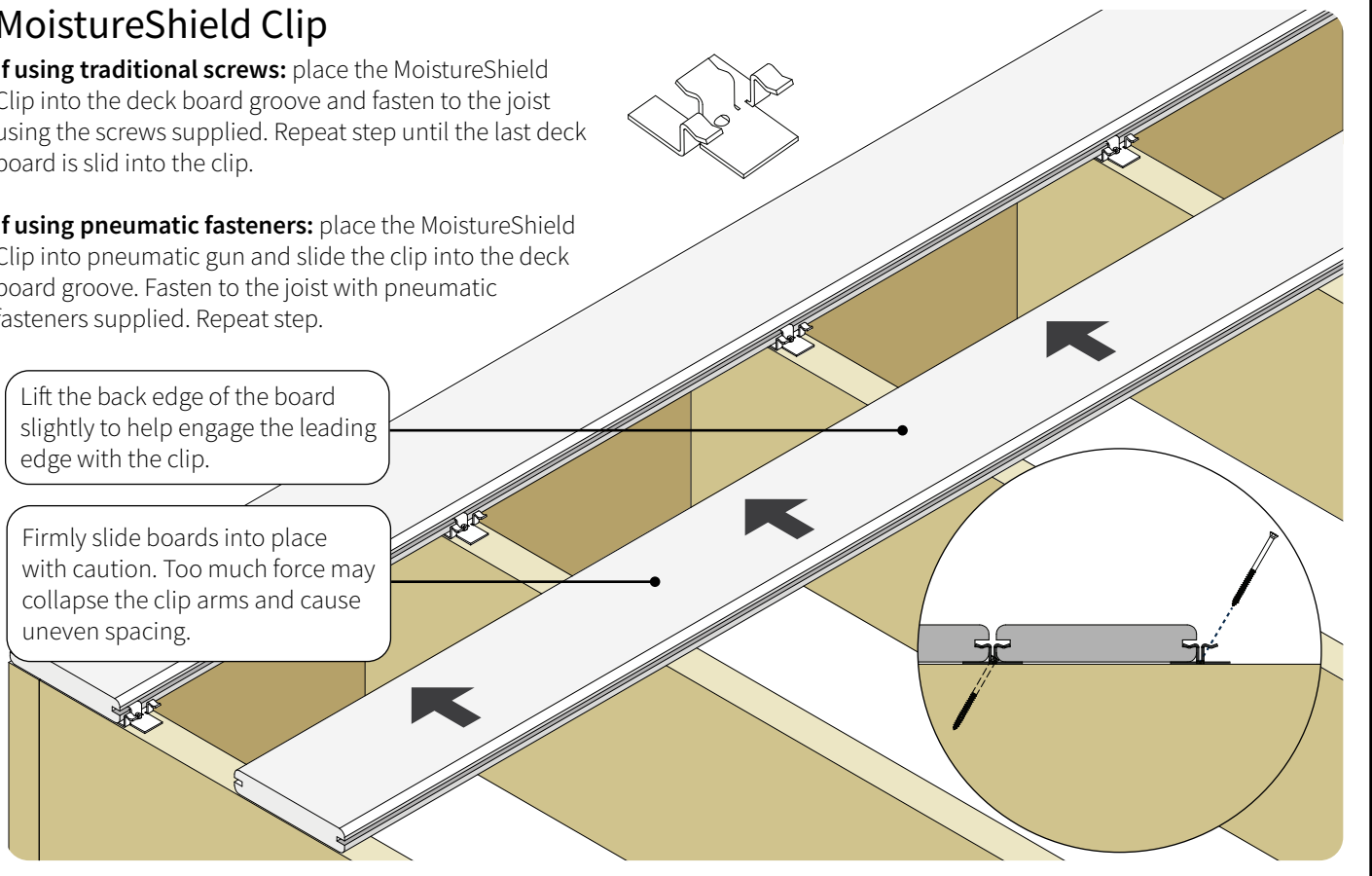
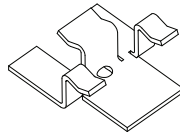

Finishing Clip

The Finishing Clip can be installed 1 of 2 ways. Use a solid edge board as the final deck board to create a finished look. Cut the inside edge of the last board with a biscuit joiner or router.

Finishing Clips are only compatible with solid profiles to ensure proper bite into the bottom side of the board. **Do not use finishing clips with Elevate.**

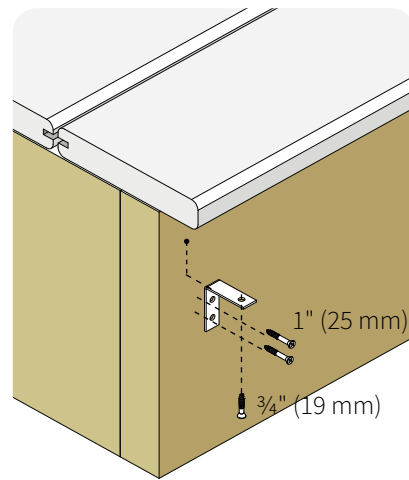
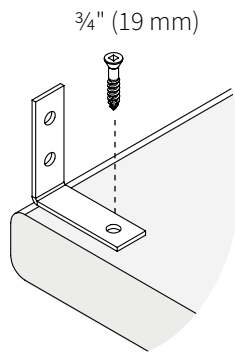
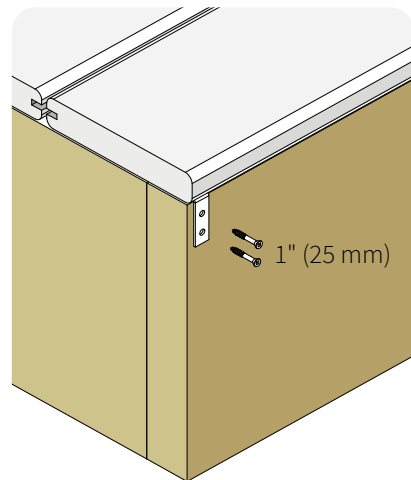
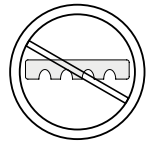

Confirm the maximum overhang before proceeding.

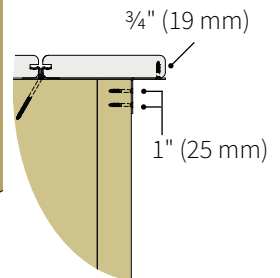

A. Flush to the outside edge of the rim joist:

Attach the Finishing Clip base (with one hole) to the underside of the board using the short screw provided in the pack. The leg should be flush with the outer edge of the deck board. Tap the inside edge of the last board into the final row of exposed clips. Secure the Finishing Clip leg (with two holes) into the joist with the long screws provided in the pack.

B. Overhang the outside edge of the rim joist:

Attach the Finishing Clip base (with one hole) to the underside of the board using the short screw provided in the pack. The leg should be placed where it will meet the rim joist. Tap the inside edge of the last board into the final row of exposed clips. Secure the Finish Clip leg (with two holes) into the joist with the long screws provided in the pack.



Feature Board

For an interesting design, install a feature board with Transitional Clips to define spaces within the decking surface or eliminate staggered butt joints.

Install joists to accommodate fasteners at the ends of the boards abutting the feature board.

Use spacers to ensure a consistent gap between the edges of the feature board and the abutting board ends to allow for proper expansion and contraction.

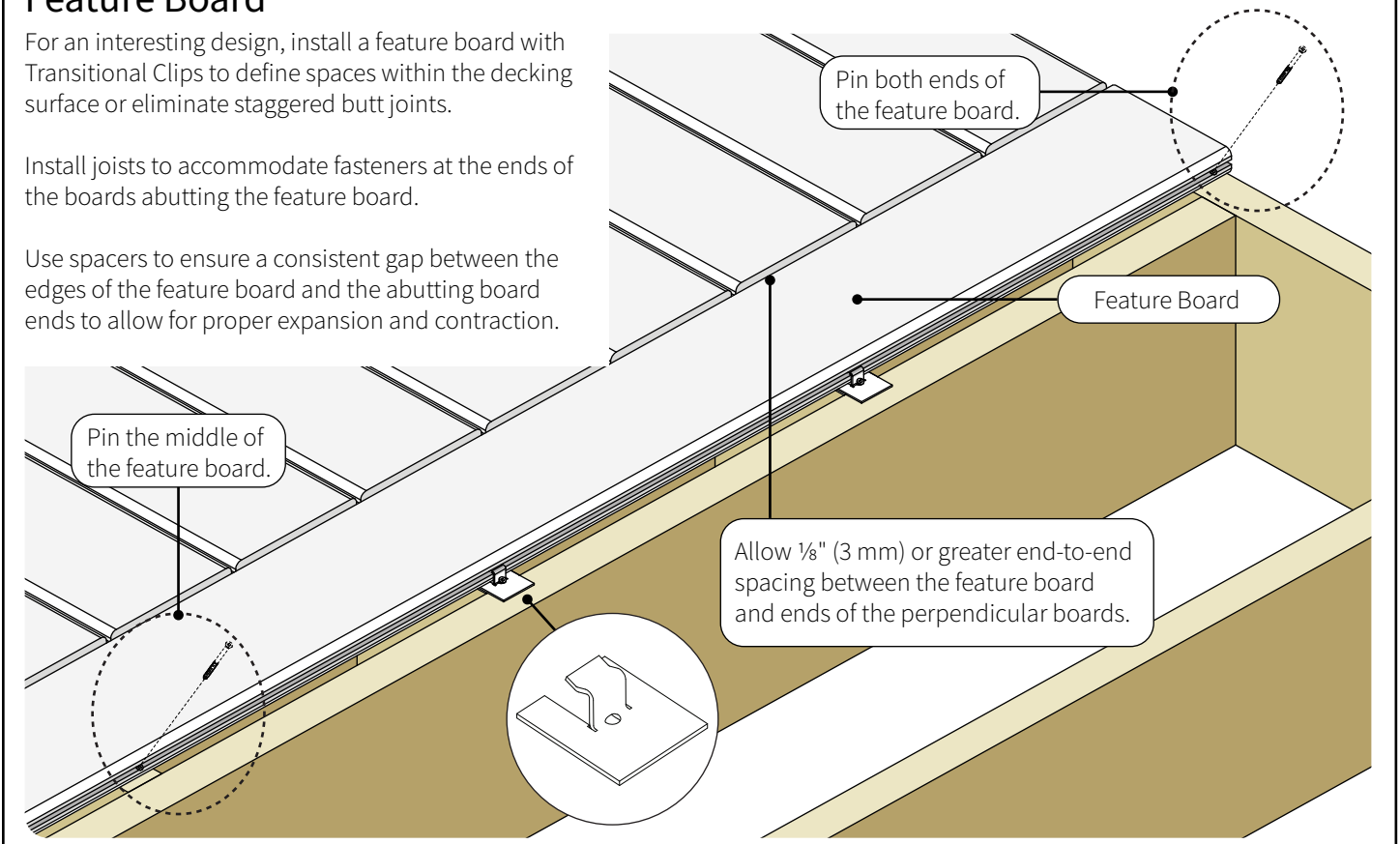

Butt Joints

The end of each board that meets at a butt joint must be secured to a separate joist. Install sister joists as needed.

- For butt joints that are continuous the length of the joist, add a second joist to the primary joist to accommodate the second fastener.
- For random butt joints, secure a second piece of joist (approximately 18" in length) to the joint area.

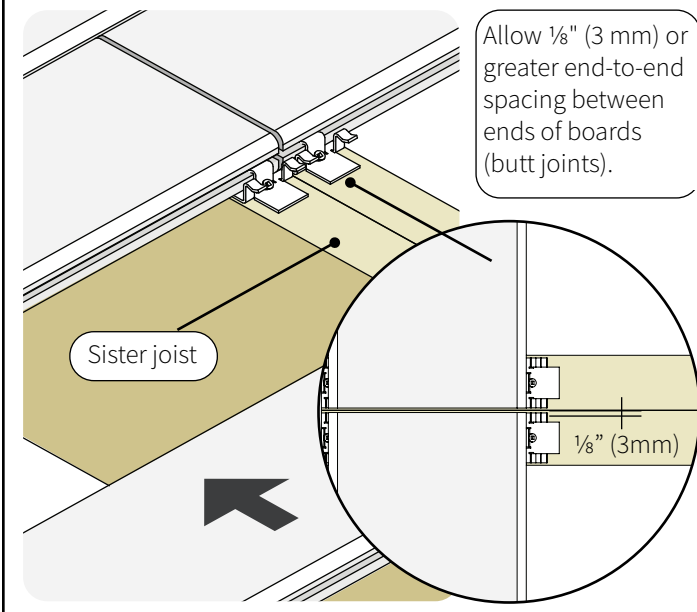

Pinning

Feature boards installed with hidden fasteners should be pinned to help limit the board's movement and maintain consistent gapping through seasonal temperature and moisture changes.

Use #7 stainless steel trimhead screws inserted at an angle into the groove. Align the pin to the center of the joist.

Affix a pin at both ends of the feature board and at the joist location closest to the middle of the board.

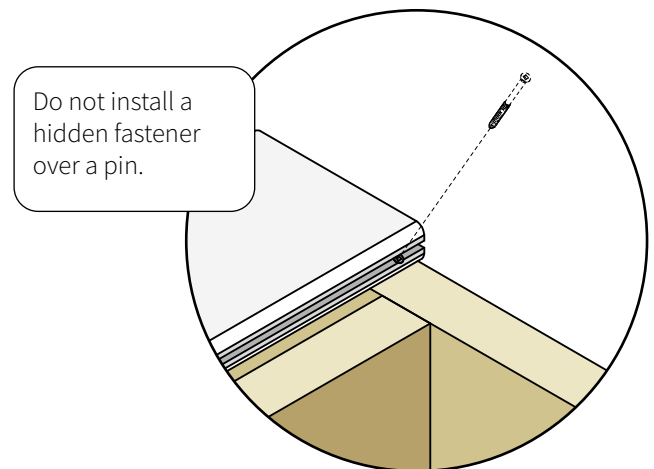

General Cleaning & Maintenance

As with all exterior products, periodic cleaning will help keep your deck looking its best. Below are recommendations for specific cleaning issues. If you have any questions or concerns about caring for your deck please call our Customer Service Team at 866.729.2378 or contact us online.

MoistureShield series that include a Fade and Stain Warranty should be cleaned within one week of exposure to prevent voiding the stain warranty. Refer to the MoistureShield Warranty document for coverage details.

ISSUE	SOLUTION
Dirt & Debris	Remove dirt and debris once per week with a broom or leaf blower. Use mild soap and warm water with a nylon scrub brush to gently remove dirt and grime as needed.
ALLOW MOISTURESHIELD VANTAGE PRODUCTS TO WEATHER NATURALLY FOR 3 TO 6 MONTHS BEFORE PROCEEDING WITH THE BELOW CLEANING METHODS.	
Bio Stains & Mold	Apply Olympic Premium Deck Cleaner* as directed; this is a bleach-based cleaner and may lighten the deck's surface appearance. For optimal results, apply over the entire deck surface to maintain color continuity. For lasting results after cleaning, use Spray and Forget* to help inhibit mold development. As a preventative measure, Spray and Forget can be used once a year in high mold environments. Read and follow all instructions and safety precautions provided by the cleaning product manufacturer before proceeding. Wear appropriate protective gear, such as safety glasses and gloves.
Water spots, Tannin Stains, Rust Stains	Use a deck brightener* containing oxalic acid to remove these spots. Deck brightener will cause the deck boards to lighten. For optimal results, apply over the entire deck surface to maintain color continuity.
Food Oil & Grease Stains	Use a household degreasing agent, such as dishwashing liquid, to remove food-grade oil and grease stains as soon as the stain is noticed. Apply with warm water and gently scrub the area with a nylon brush. Thoroughly rinse the detergent off the deck with warm water. If the stain sits for more than two hours, the most effective method of removal is with an oil stain remover formulated for decking.
Pressure Washing	Pressure wash as needed to remove built-up grime. Pressure washing with too much pressure can cause irreversible damage to composite decking. Use no more than 1300 PSI and keep the wand at least 10 inches from the deck surface.
Snow & Ice	Use a clear ice melt formula or rock salt to prevent accidental stains on your deck from these materials. Select ice melt that indicates it's safe for use on concrete and flagstone, as well as safe for children and pets. Remove excess ice melt or salt from your deck with a push broom. Clean your deck as soon as outdoor temperatures permit with warm soapy water and a thorough rinse to ensure the surface is clear of any remaining ice melt or rock salt. Do not use sharp tools (such as metal shovels, metal or plastic ice picks) to clear snow and ice. They can accidentally gouge your deck surface. Do not apply sand over your decking to create traction. Sand is highly abrasive and can scratch any composite decking surface.
Scratches & Surface Abrasions	Vantage products have self-healing properties which make scratches and scuffs less severe and noticeable over time through exposure to heat and sunlight. See additional information in the Addressing Damaged Boards section.

*Follow all package directions for proper usage, safety precautions and disposal. In some cases, more stubborn stains will require reapplying cleaners until the desired level of cleanliness is achieved. Remember to always test chosen cleaners in a small inconspicuous area of your deck for approved results. Never mix other cleaners (ammonia, phosphoric acid, etc.) with bleach.



Damaged Boards

MoistureShield composite decking features our innovative Solid Core Difference™, a proprietary barrier that fights against damage from moisture, rot, insects and other harmful elements. MoistureShield boards are far more durable than natural wood decking or pressure-treated deck boards, so you'll spend less time maintaining your deck and more time enjoying your deck.

MoistureShield boards are built to withstand typical use. Light scratches on our uncapped Vantage series boards will fade in 12 - 16 weeks due to its self-healing properties. Our Elevate, Meridian, and Vision series feature polymer caps, offering levels of enhanced scratch resistance built right in the board.

Areas with heavy damage, such as deep abrasions or broken boards, may require replacement of affected boards. Steps for replacing boards depend on the type of fastener used to secure them to the joists. Reference the following step-by-step instructions for Face Screws or Hidden Fasteners.

DO NOT sand the top surface of composite decking boards to remove scratches. Sanding will remove the embossed surface texture and cause discoloration.

DO NOT attempt to fill deep scratches with putty or wood fillers. These materials will not adhere to composite decking due to the plastic content.

DO NOT apply paints, stains, or sealers to repair scratches or change the overall look of your composite decking. These products will not adhere to composite decking due to the plastic content.



Board Replacement - Face Screws

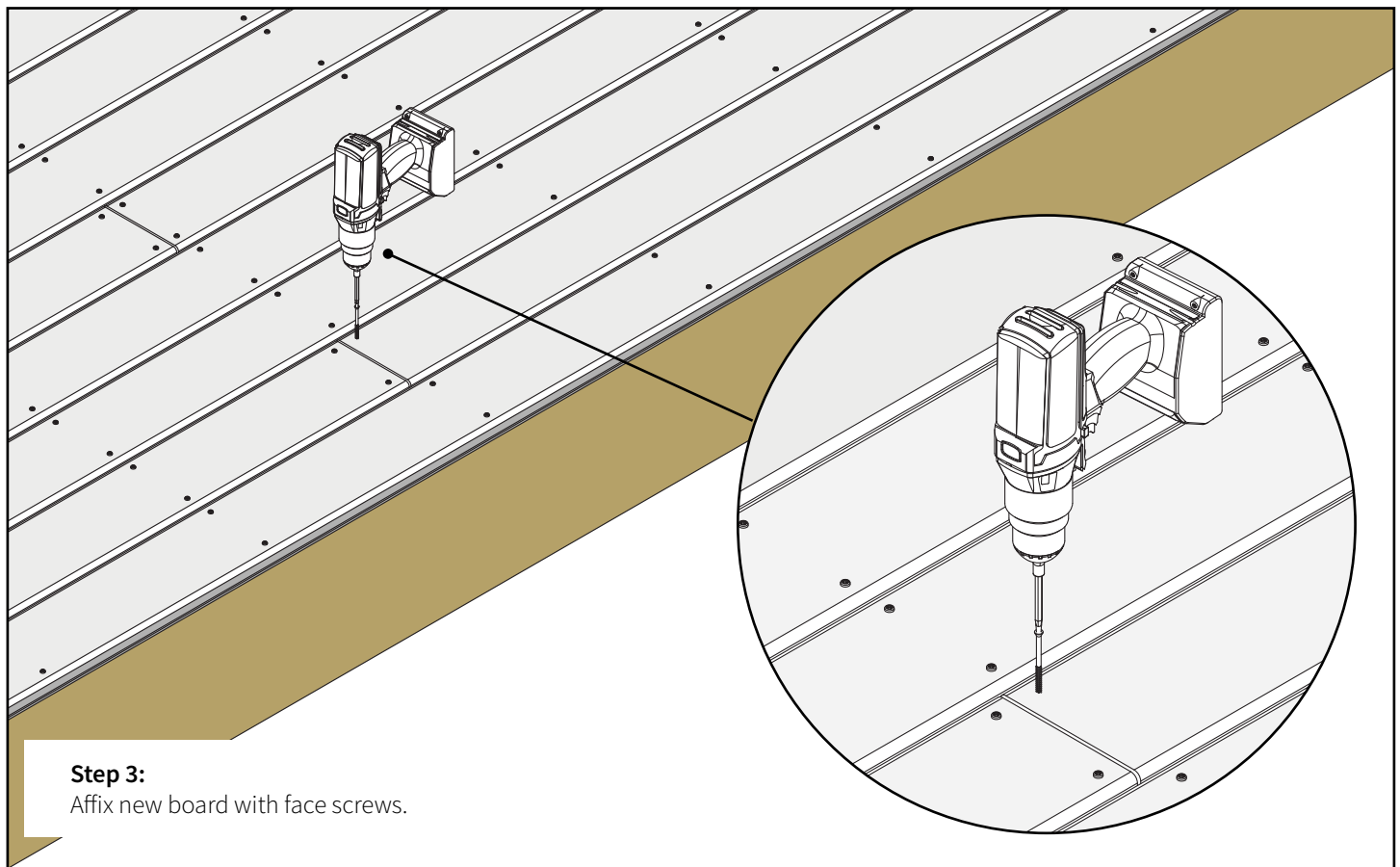
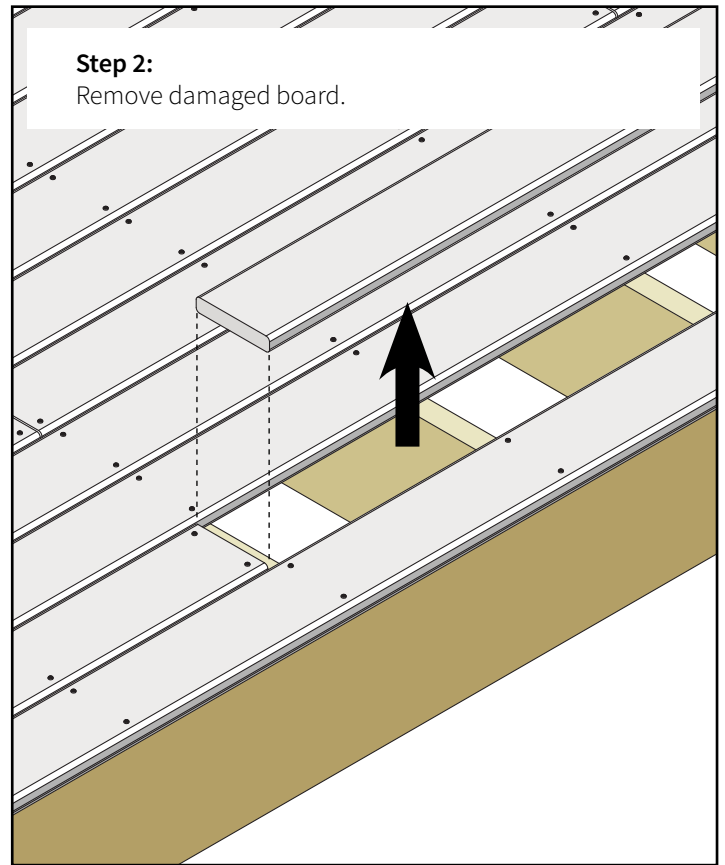
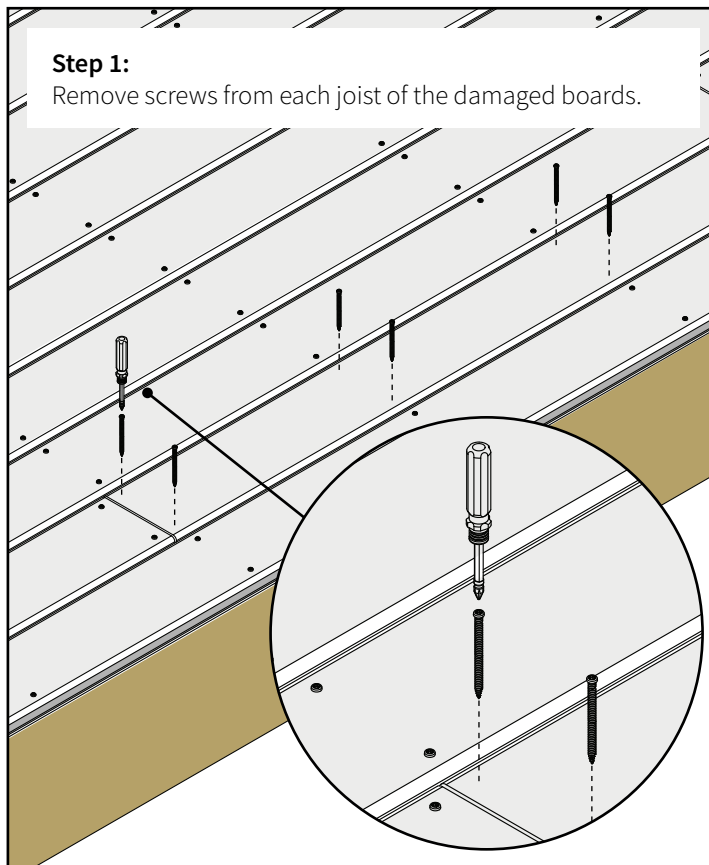

Board Replacement - Hidden Fasteners

Step 1:

Cut with a circular saw two parallel slots the length of the deck board. Cutting the two slots will result in the deck board being cut into three pieces.

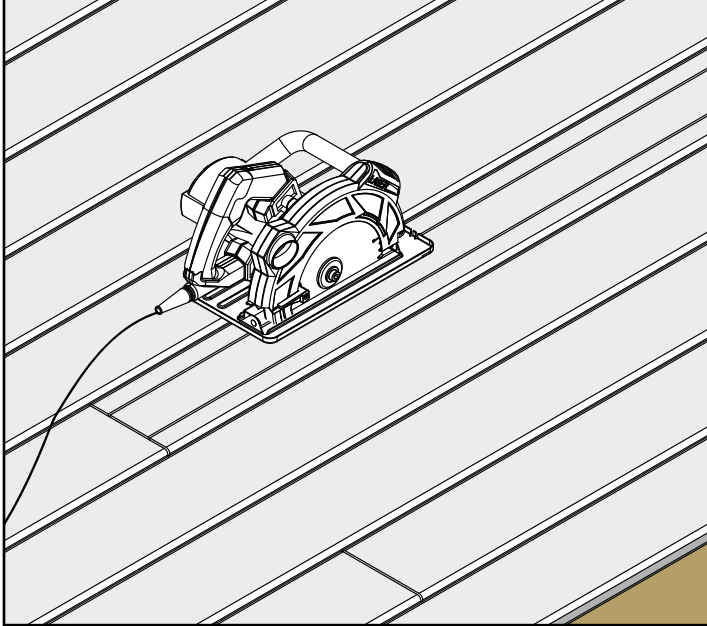

Step 2:

Remove all three pieces of the deck board.

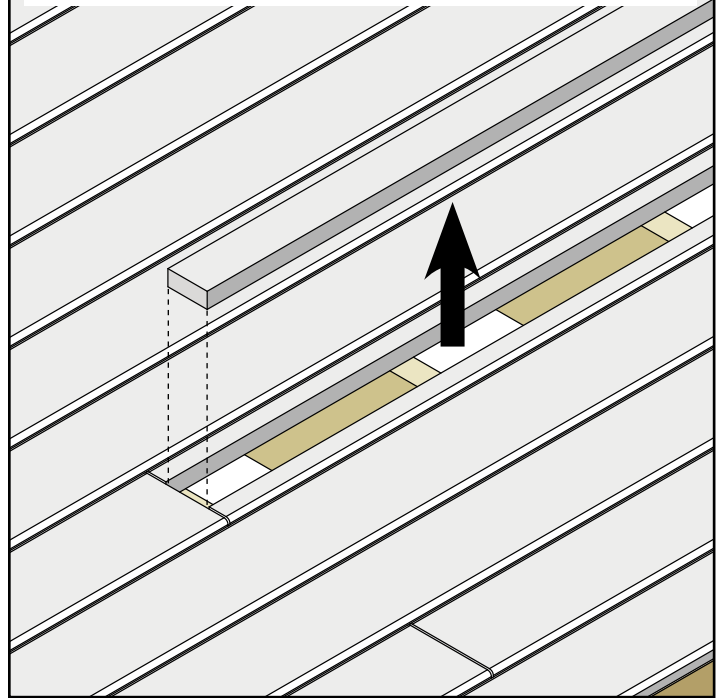

Step 3:

Remove the tabs from the clip that has two arms sticking out by bending them back and forth with pliers or cut them with a side grinder.

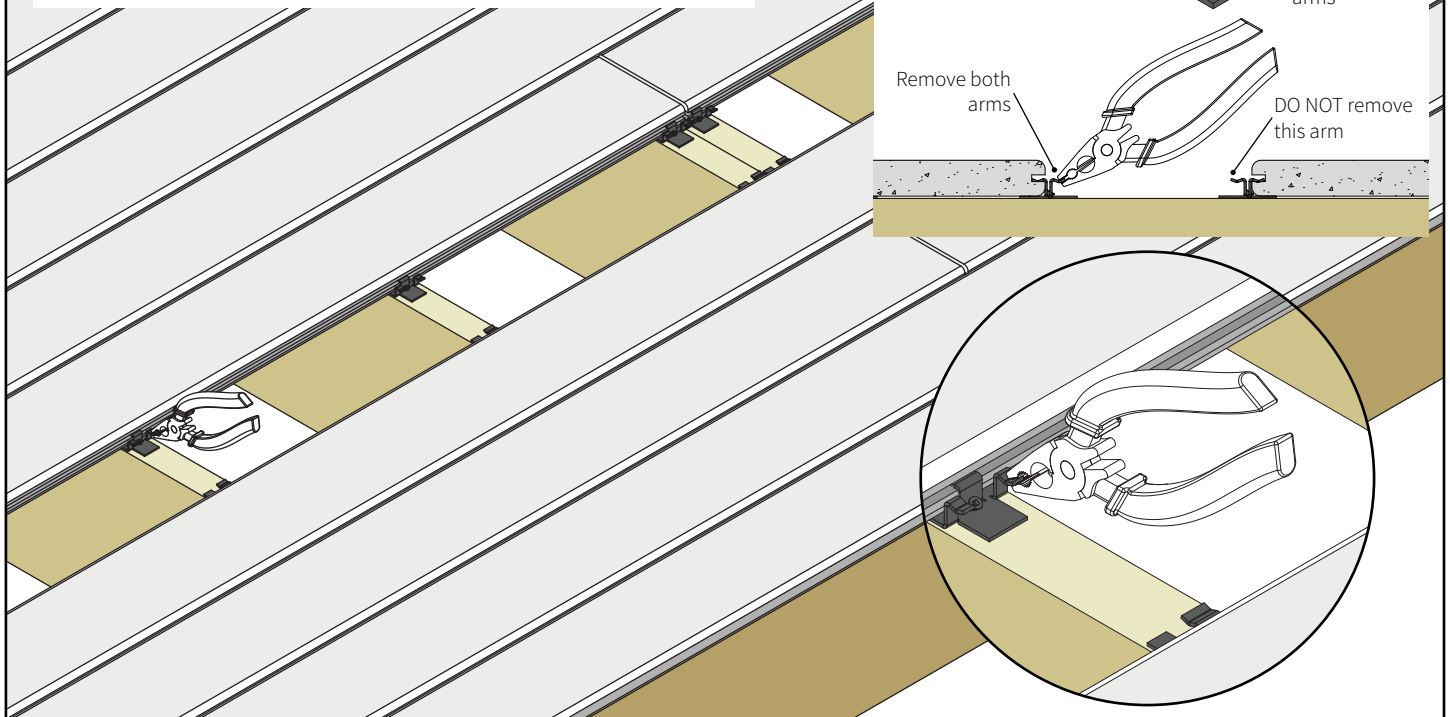

Board Replacement - Hidden Fasteners

Step 4:

Slide the new deck board into the clip that still has the one tab remaining.

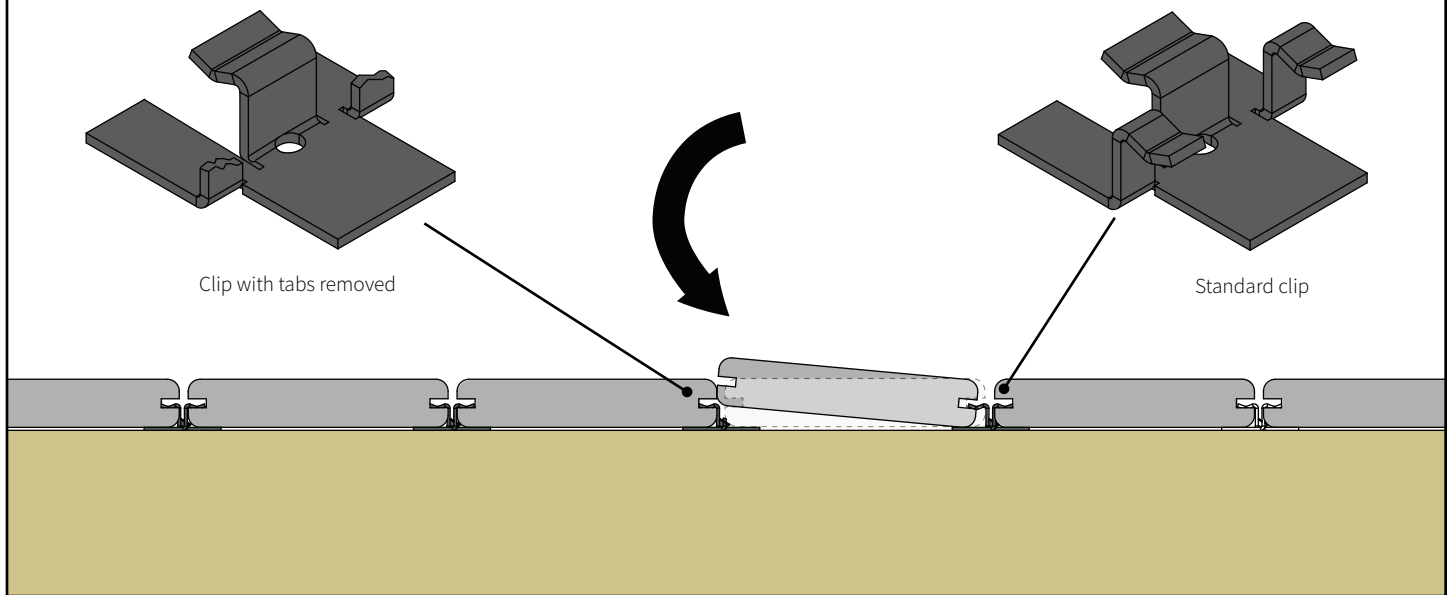

Step 5:

Fasten down the other side of the deck board using a color match face screw or plug system.

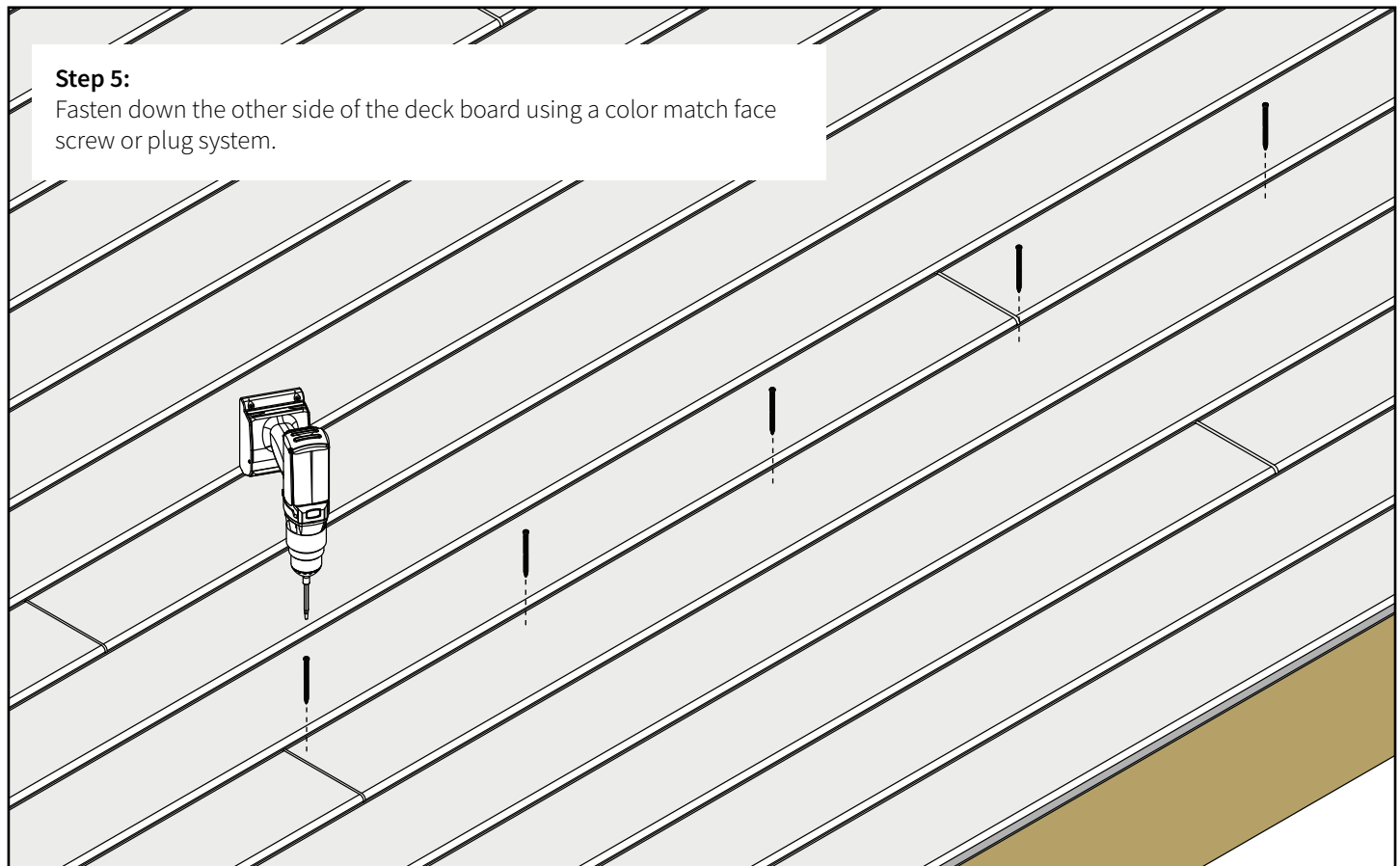

NOTES

Use this section to sketch your design ideas!

Visit moistureshield.com or your local MoistureShield dealer for samples of your favorite series and colors.

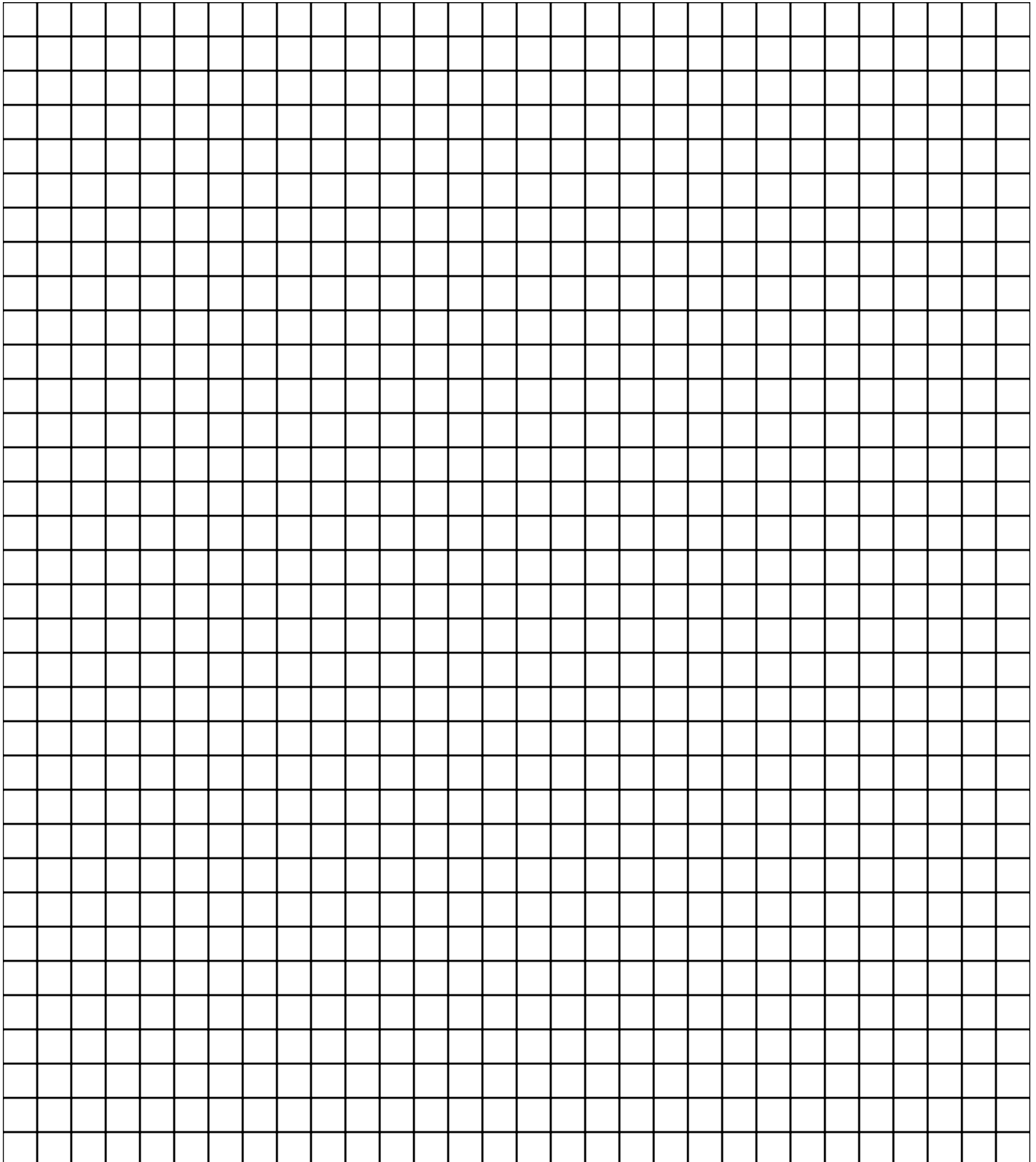



[MOISTURESHIELD.COM](https://www.moistureshield.com)